



Official Website



APP (iOS)



APP (Android)



340-00004-03 Version: 1.0



Jiangsu GoodWe Power Supply Technology Co.,Ltd

No.189 Kun Lun Shan Road, SND, Jiangsu, China.

www.goodwe.com

service@goodwe.com

ES SERIES USER MANUAL

DATA VERIFIED BY
SOLAR ANALYTICA.

HYBRID INVERTER

TABLE OF CONTENTS

01 INTRODUCTION

1.1 OPERATION MODES INTRODUCTION	01
1.2 SAFETY & WARNINGS	02
1.3 PRODUCT OVERVIEW	04

02 INSTALLATION INSTRUCTIONS

2.1 UNACCEPTABLE INSTALLATIONS	05
2.2 PACKING LIST	05
2.3 MOUNTING	06
2.3.1 SELECT MOUNTING LOCATION	06
2.3.2 MOUNTING	07
2.4 ELECTRICAL WIRING CONNECTION	08
2.4.1 PV CONNECTION	08
2.4.2 BATTERY CONNECTION	09
2.4.3 ON-GRID & BACK-UP CONNECTION	11
2.4.4 EZMETER & CT CONNECTION	13
2.5 DRED & EARTH FAULT ALARM	14
2.5.1 DRED CONNECTION	14
2.5.2 EARTH FAULT ALARM	14

03 MANUAL OPERATION

3.1 WIFI CONFIGURATION & WIFI RELOAD	17
3.2 PV MASTER APP OPERATION	18
3.3 CEI AUTO-TEST INSTRUCTION	18

04 OTHERS

4.1 ERROR MESSAGE AND TROUBLESHOOTING	19
4.2 DISCLAIMER	25
4.3 TECHNICAL PARAMETERS AND CERTIFICATES	26
4.4 WARINING QUICK CHECK LIST	28

01 INTRODUCTION

GoodWe ES series, also called hybrid or bidirectional solar inverters, apply to solar system with participation of PV, battery, loads and grid system for energy management. The energy produced by PV system shall be used to optimize self-consumption, excess power charge battery and the rest power could be exported to the grid. Battery shall discharge to support loads when PV power is insufficient to meet self-consumption. If battery power is not sufficient, the system will take power from grid to support loads.

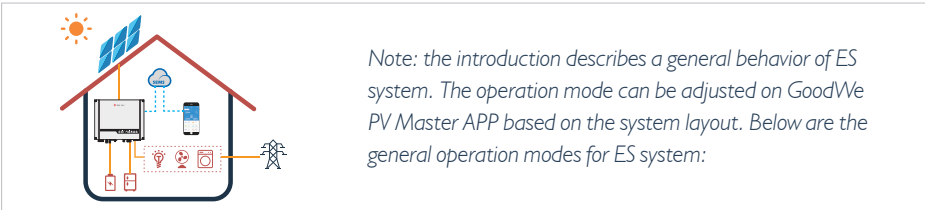

01 I.1 OPERATION MODES INTRODUCTION

ES system normally has the following operation modes based on your configuration and layout conditions

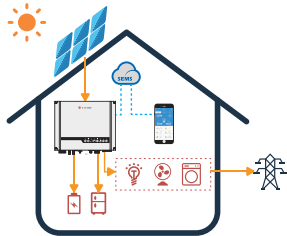

Mode I

The energy produced by the PV system is used to optimize self-consumption. The excess energy is used to recharge the batteries, then exported to grid.

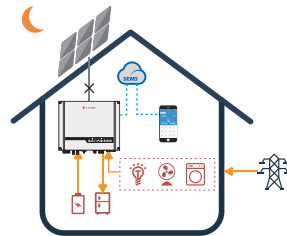

Mode II

When there is no PV, and the battery is sufficient, it can supply the load together with grid power.

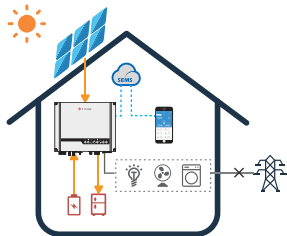

Mode III

When grid fails, the system automatically switches to Back-Up mode. The Back-Up load can be supported by PV and battery.

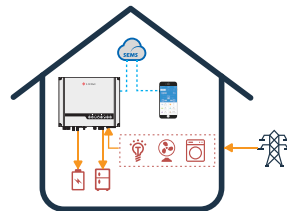

Mode IV

Battery can be charged by grid, and charging time/power can be set flexibly on PV Master APP.

I.2 SAFETY & WARNING

The ES series inverters of Jiangsu GoodWe Power Supply Technology Co., Ltd. (hereinafter called as GoodWe) strictly comply with related safety rules for product design and testing. Please read and follow all the instructions and cautions on the inverter or user manual during installation, operation or maintenance, as any improper operation might cause personal or property damage.

• SYMBOLS EXPLANATION



Caution!
Failing to observe a warning indicated in this manual may result in injury.



Danger of high voltage and electric shock!



Danger of hot surface!



Components of the product can be recycled.



This side up! The package must always be transported, handled and stored in such a way that the arrows always point upwards.



No more than six (6) identical packages being stacked on each other.



Product should not be disposed as household waste.



The package/product should be handled carefully and never be tipped over or slung.



Refer to the operating instructions.



Keep dry! The package/product must be protected from excessive humidity and must be stored under cover.



Inverter will be touchable or operable after minimum 5 minutes of being turned off or totally disconnected, in case of any electrical shock or injury.



CE Mark

• SAFETY WARNING

Any installation and operation on inverter must be performed by qualified electricians, in compliance with standards, wiring rules or requirements of local grid authorities or companies (like AS 4777 and AS/NZS 3000 in Australia).

Before any wiring connection or electrical operation on inverter, all DC and AC power must be disconnected from inverter for at least 5 minutes to make sure inverter is totally isolated to avoid electric shock.

The temperature of inverter surface might exceed 60 C during working, so please make sure it is cooled down before touching it, and make sure the inverter is untouchable for children.

Do not open inverter cover or change any components without GoodWe's authorization, otherwise the warranty commitment for the inverter will be invalid.

Usage and operation of the inverter must follow instructions in this user manual, otherwise the protection design might be useless and warranty for the inverter will be invalid.

Appropriate methods must be adopted to protect inverter from static damage. Any damage caused by static is not warranted by GoodWe.

PV negative (PV-) on inverter side is not grounded as default design.

PV modules used on the inverter must have an IEC61730 class A rating, and the total open-circuit voltage of PV string/array is lower than the maximum rated DC input voltage of the inverter. Any damage caused by PV over-voltage is beyond warranty.

The inverter, with built-in RCMU, will exclude possibility of DC residual current to 6mA, thus in the system an external RCD (type A) can be used(≥30mA).

In Australia, the inverter internal switching does not maintain neutral integrity, which must be addressed by external connection arrangements like in the Off-Grid System Connection Diagram in page 16.

IN Australia, output of Back-Up side in switchbox should be labeled 'Main Switch UPS supply', the output of normal load side in switch box should be labeled 'Main Switch Inverter Supply'.

1.3 PRODUCT OVERVIEW

INDICATOR	STATUS	EXPLANATION	HYBRID LED INDICATORS							
			SYSTEM	BACK-UP	SOLAR	BATTERY	GRID	ENERGY	WIFI	FAULT
SYSTEM	ON = SYSTEM IS READY BLINK = SYSTEM IS STARTING UP OFF = SYSTEM IS NOT OPERATING		Green	Green	Blue	Blue	Blue	Yellow	Yellow	Red
BACK-UP	ON = BACK-UP IS READY / POWER AVAILABLE OFF = BACK-UP IS OFF / NO POWER AVAILABLE		Green	Green	Blue	Blue	Blue	Blue	Blue	Blue
SOLAR	ON = SOLAR INPUTS #1 AND #2 ARE ACTIVE BLINK 1 = SOLAR INPUT #1 IS ACTIVE / #2 IS NOT ACTIVE BLINK 2 = SOLAR INPUT #2 IS ACTIVE / #1 IS NOT ACTIVE OFF = SOLAR INPUT #1 AND #2 ARE NOT ACTIVE		Blue	Blue	Blue	Blue	Blue	Blue	Blue	Blue
BATTERY	BLINK 1 = BATTERY IS DISCHARGING BLINK 2 = BATTERY IS LOW / SOC IS LOW OFF = BATTERY IS DISCONNECTED / NOT ACTIVE		Blue	Blue	Blue	Blue	Blue	Blue	Blue	Blue
GRID	ON = GRID IS ACTIVE AND CONNECTED BLINK = GRID IS ACTIVE BUT NOT CONNECTED OFF = GRID IS NOT ACTIVE		Blue	Blue	Blue	Blue	Blue	Blue	Blue	Blue
ENERGY	ON = CONSUMING ENERGY FROM GRID / BUYING BLINK 1 = SUPPLYING ENERGY TO GRID / ZEROING BLINK 2 = SUPPLYING ENERGY TO GRID / SELLING OFF = GRID NOT CONNECTED OR SYSTEM NOT OPERATING		Yellow	Yellow	Yellow	Yellow	Yellow	Yellow	Yellow	Yellow
WIFI	ON = WIFI CONNECTED / ACTIVE BLINK 1 = WIFI SYSTEM RESETTNG BLINK 2 = WIFI NOT CONNECT TO ROUTER BLINK 4 = WIFI SERVER PROBLEM OFF = WIFI NOT ACTIVE		Yellow	Yellow	Yellow	Yellow	Yellow	Yellow	Yellow	Yellow
FAULT	ON = FAULT HAS OCCURRED BLINK = OVERLOAD OF BACK-UP OUTPUT / REDUCE LOAD OFF = NO FAULT		Red	Red	Red	Red	Red	Red	Red	Red

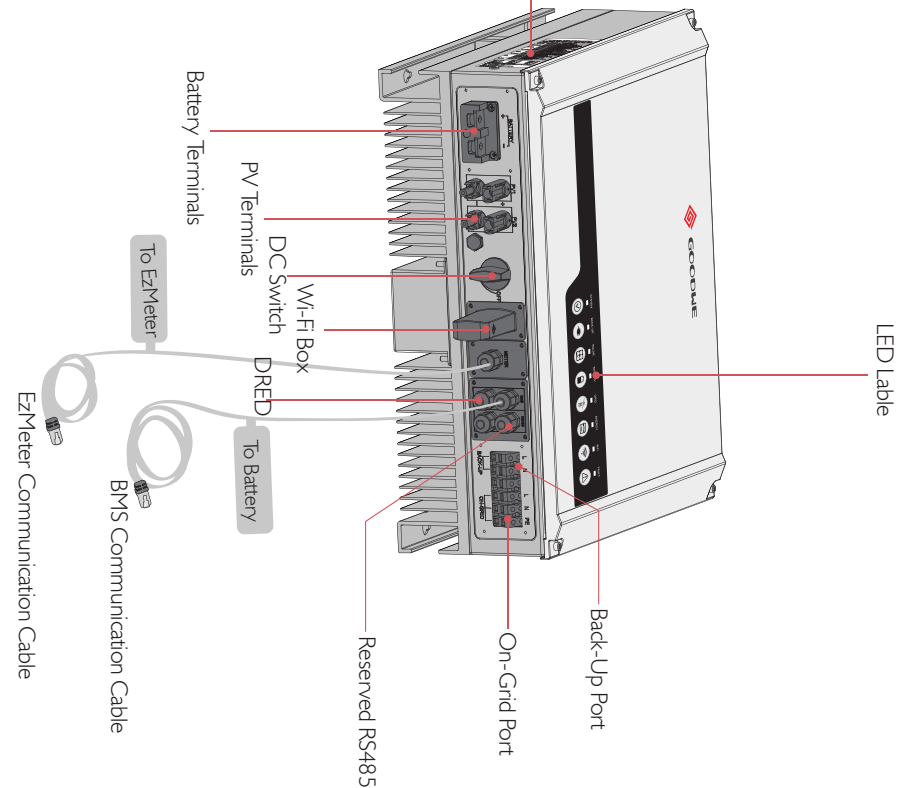

02 INSTALLATION INSTRUCTIONS

2.1 UNACCEPTABLE INSTALLATIONS

Please avoid the following installations, which will damage the system or the inverter.

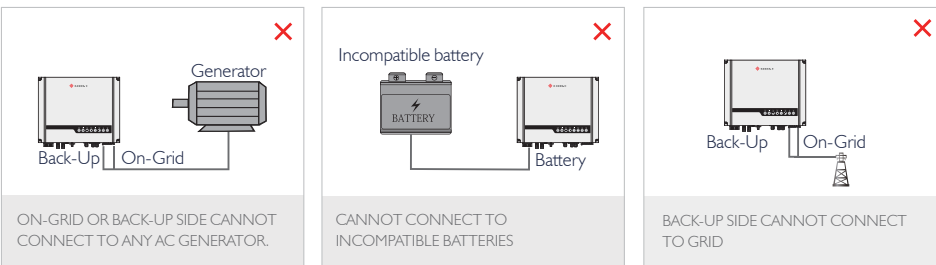
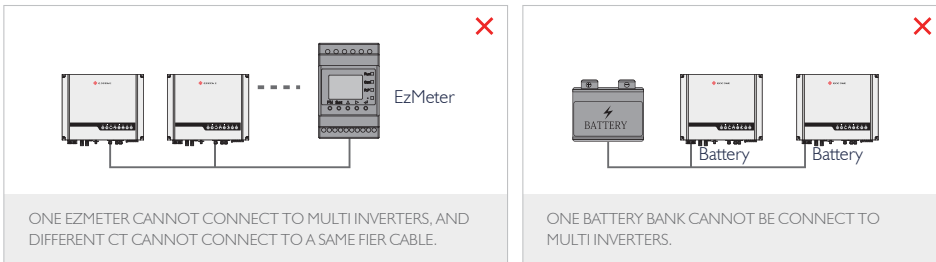
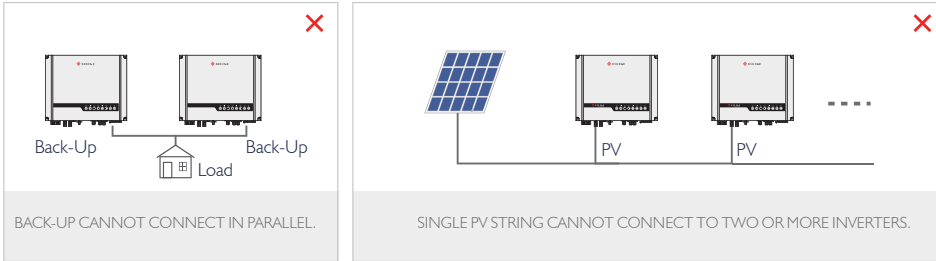

2.2 PACKING LIST

On receiving the inverter, please check to make sure all the components as below are not missing or broken.

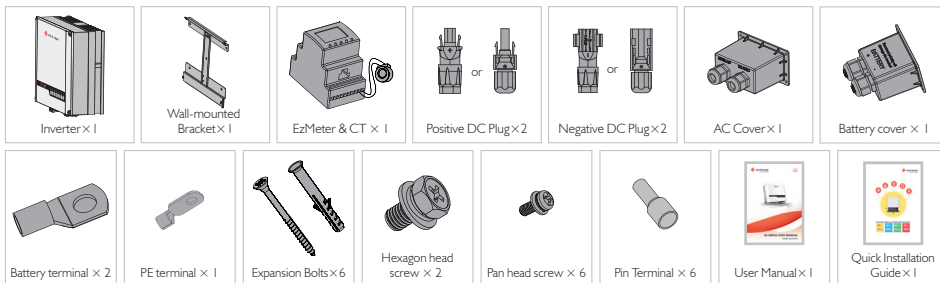

2.3 MOUNTING

2.3.1 SELECT MOUNTING LOCATION

For inverter's protection and convenient maintenance, mounting location for inverter should be selected carefully based on the following rules:

Rule 1. Inverter should be installed on a solid surface, where is suitable for inverter's dimensions and weight.

Rule 2. Inverter installation should stand vertically or lie on a slop by max 15° (Pic 1)

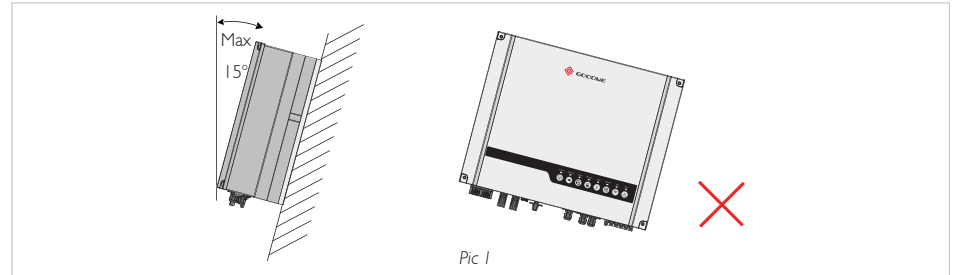

Rule 3. Ambient temperature should be lower than 45°C

Rule 4. The installation of inverter should be protected under shelter from direct sunlight or bad weather like snow, rain, lightning etc. (Pic 2)

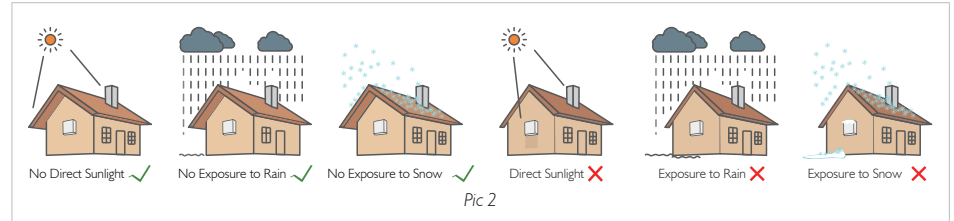

Rule 5. Inverter should be installed at eye level for convenient maintenance.

Rule 6. Product label on inverter should be clearly visible after installation.

Rule 7. Leave enough space around inverter following the values on pic 3.

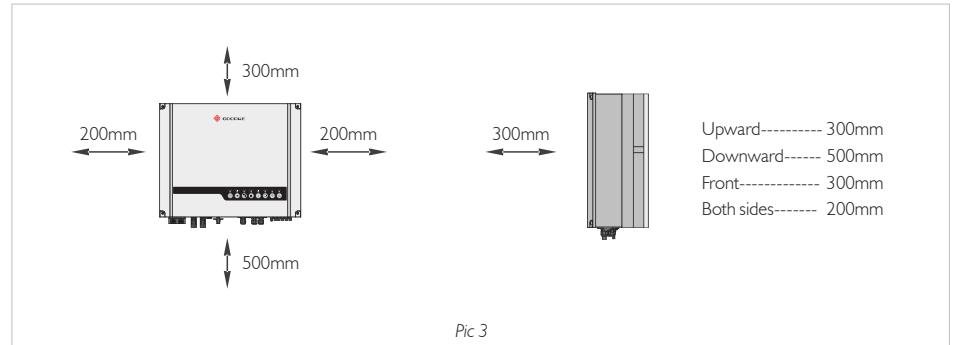

Inverter cannot be installed near flammable, explosive or strong electro-magnetic equipment.^[1]

2.3.2 MOUNTING

 Remember that this inverter is heavy! Please be careful when lifting out from the package.^[2]

The inverter is suitable for mounting on concrete or other non-combustible surface only

Step 1

- Please use the mounting bracket as a template to drill 6 holes on right positions (10mm in diameter, and 80mm in depth) (Pic 4)
- Use expansion bolts in accessory box and fix the mounting bracket onto the wall tightly

NOTE: Bearing capacity of the wall must be higher than 30KG, otherwise may not be able to keep inverter from dropping.

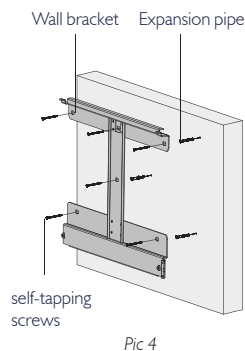

07

Step 2

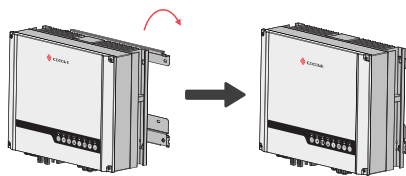

Carry the inverter by holding the heating sink on two sides and Place the inverter on the mounting bracket. (Pic 5)

NOTE: Make sure the heat sink on inverter is rightly joint with mounting bracket.

Step 3

Ground cable shall be connected to ground plate on grid side (Pic 6)

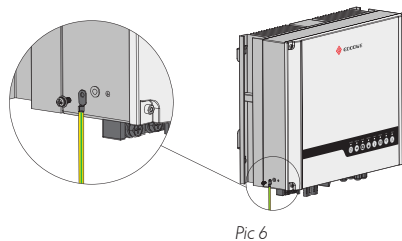

Step 4

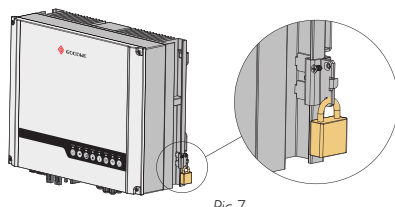

A lock could be used for anti-theft if it is necessary for individual requirement. (Pic 7)

2.4 ELECTRICAL WIRING CONNECTION

2.4.1 PV CONNECTION

Before connecting PV panels/strings to inverter, please make sure requirements are followed as below :

- The total short-circuit current of PV string must not exceed inverter's max DC current
- The minimum isolation resistance to ground of the PV string must exceed 18.33kΩ in case of any shock hazard
- PV strings could not connect to earth/grounding conductor
- Use the DC plugs in the accessory box

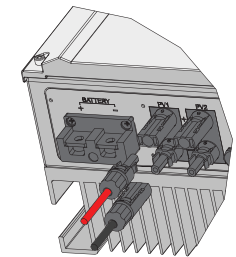

NOTE: There will be MC4 or Amphenol DC plugs in accessory box, the detailed connection as below:

Step 1

Prepare PV cables and DC plugs (Pic 8)

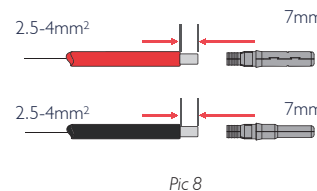

NOTE:

- Please use DC plugs and connectors in GoodWe accessory box
- PV cable should be standard, 2.5-4mm² PV cable

Step 2

Connect PV cable to DC connectors (Pic 9)

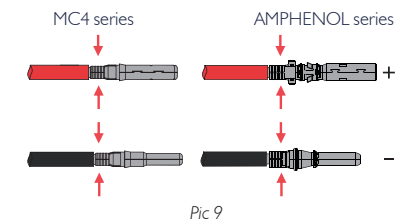

NOTE:

- PV cable must be tightly crimped into the connectors
- For Amphenol connector, the limit buckle cannot be pressed
- There will be a click sound if connectors are inset correctly into DC plugs

08

Step 3

Screw the cap on and plug onto inverter side (Pic 10)

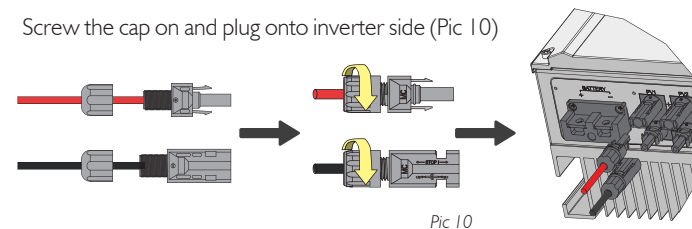

NOTE:

- There will be a click sound if connectors are inset correctly into DC plugs



The polarity of PV strings or on the inverter cannot be connected by reverse, otherwise inverter could be damaged.^[3]

2.4.2 BATTERY CONNECTION

- For lithium battery (pack) the capacity should be 50Ah or larger. Lead acid batteries are not allowed to use with GoodWe hybrid inverters without GoodWe's authority. Battery cable requirement as below. (Pic 11)



Grade	Description	Value
A	O.D.	10-12mm
B	Isolation section	NA
C	Conductor Core	20-25mm ²

Pic 11

- Please be careful against any electric shock or chemical hazard
- Make sure there is an external DC switch (≥ 125A) connected for battery without build-in DC switch

Battery wiring connection steps as below:

! Make sure battery switch is off and battery nominal voltage meet ES specification before connecting battery to inverter and make sure inverter is totally isolated from PV and AC power.^[4]

09

Step 1

Prepare battery cables and accessories and put battery power cable through battery cover (Pic 12.)

NOTE:

- Please use accessories from GoodWe box
- Battery power cable should be 20-25 mm²

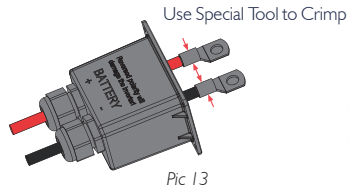
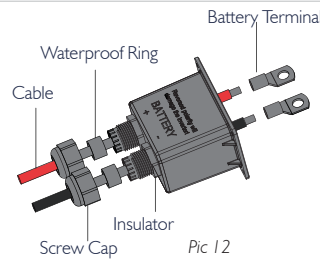

Make battery terminals (Pic 13)

- Strip cable coat, revealing 10mm length of metal core
- Use special crimper to compress battery terminal tightly

Step 2

Step 3

Connect battery terminals onto inverter (Pic 14)

NOTE: Please make sure polarity (+/-) of battery are not reversed

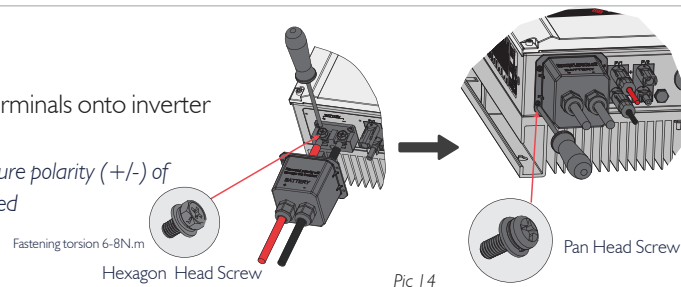

* For the compatible lithium batteries (LG/Pylon/BYD/GCL) connection, please refer to battery connection part in ES QUICK INSTALLATION INSTRUCTIONS.

• FOR LEAD-ACID BATTERIES

Lead-Acid and other similar older-technology battery types require experienced and precise design, installation and maintenance to work effectively. For details, please refer to *Approved Battery Option Statement* (download from www.goodwe.com)

For lead-acid battery bank, the inconformity between battery cells might lead to battery cell over-charge or discharge, and further might damage battery cells and shorten battery bank life

For ES series inverters there is no temperature compensation, thus customers need do battery settings based on the real working temperature of battery.

For lead-acid battery settings on PV Master App, please honestly refer to battery specifications and the actually battery work condition like work temperature and battery age. Unsuitable settings will lead to higher SOC deviation, weaker battery lifespan and further battery damage.

For lead-acid batteries, battery SOC calculation might not be so accurate result from like battery inconformity between cells, battery aging or other specifications of lead-acid battery etc.

GoodWe will keep the right for explanation on all the settings suggested and all the problems happened on lead-acid batteries or the whole system. And GoodWe is not responsible for any damage caused by unsuitable settings, battery beyond warranty or battery quality etc.

10

• BATTERY PROTECTION DESCRIPTION

Battery will act a protective charge/discharge current limitation under any condition as below:

- Battery SOC is lower than 1-DOD
- Battery voltage lower than discharge voltage
- Battery over temperature protection
- Battery communication abnormal for lithium battery
- BMS limitation for lithium battery

When charge/discharge current limitation protection happens:

- Under on-grid mode, battery charge/discharge operation could be abnormal
- Under off-grid mode, Back-Up supply will shut down

NOTE:

- Under off-grid mode, if Back-Up supply shuts off because of battery of low battery SOC or voltage, PV power will all be used to charge battery till battery SOC reaches 40% + (1-DOD)/2, then Back-Up supply will be activated up.
- Under on-grid mode, battery is protected from over discharge by DOD and discharge voltage, under off-grid mode, it is protected by only discharge voltage and DOD.
- The DOD setting of a battery prevents the inverter from discharging battery reserve power. As soon as the DOD is reached the load of building will only be supported by either PV power or from the grid. If there are continuous days when little or no battery charging occurs, the battery may continue to self-consume energy to support communications with the inverter. This behaviour is different between battery manufactures products, however, if the SOC of the battery reaches a certain level the inverter will boost the SOC back up. This protection mechanism safeguards the battery to falling to 0% SOC.

2.4.3 ON-GRID & BACK-UP CONNECTION

An external AC switch ($\geq 40A$) is needed for on-grid connection to isolate from grid when necessary. Below are the requirements on AC switch use:

Note: The absence of AC breaker on Back-Up side will lead to inverter damage if only electrical short-circuit happen on Back-Up side.

1. Use a separate AC switch for individual inverter (Pic 15)

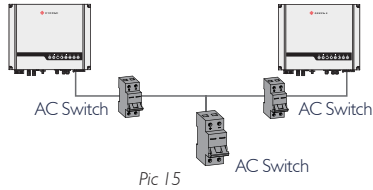

2. On AC side, the individual switch should be connected before loads (between inverter and loads) (Pic 16)

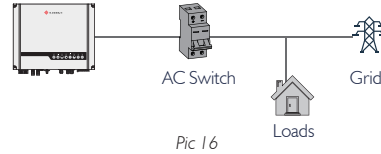

• Requirement on AC cable connected on On-Grid and Back-Up side:

! Make sure inverter is totally isolated from any DC or AC power before connecting AC cable^[5].

NOTE:

1. Neutral cable shall be blue, line cable black or brown (preferred) and protective earth cable yellow-green.
2. For AC cables, PE cable shall be longer than N & L cables, so that if in any case AC cable slips or taken out, the protecting earth conductor will be the last to take the strain

Step 1

1. Prepare the terminals and AC cables
2. Put AC cable through terminal cover follow the sequence as on the left (pic 17)

Note: Please use the terminals in GoodWe components box

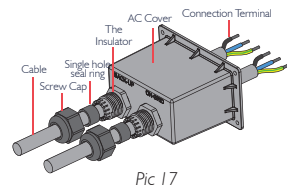

Step 2

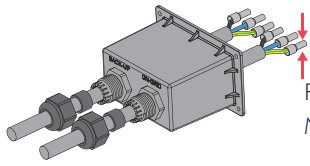

Press the six connectors on cable conductor core tightly (pic 18)
Note: Make sure cable jacket is not locked within the connector

Step 3

1. Connect the assembled AC terminals onto inverter
Note: Make sure it is not connected to a wrong side (Pic 19)
2. Lock the cover and screw the cap on

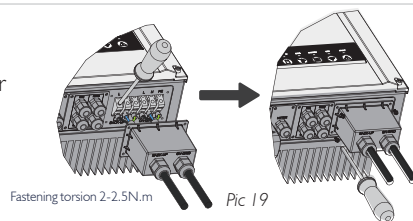

Special Adjustable Settings

The inverter has field adjustable setting like tripping point, tripping time, reconnect time, active and invalid of Q/U/PU curves etc. by special firmware. Please contact GoodWe after-sales for the special firmware and adjust methods.

Connection for SPLIT Grid System

In SPLIT grid system, there is a solution to allow inverter work under on-grid condition (Pic 20). But the export power and load power might be detected inaccurately as the nominal output power of inverter is 230V and there could be loads of 110V or 220V

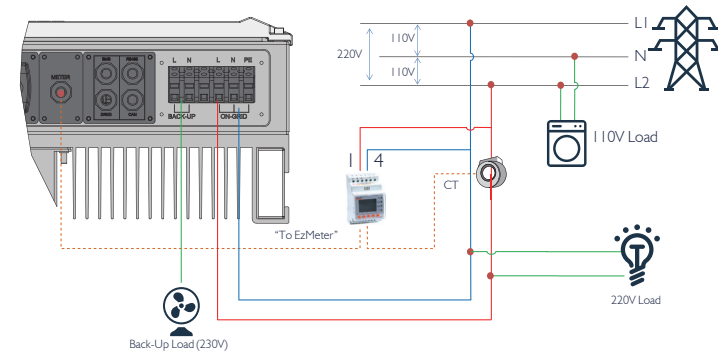

Pic 20

Declaration For Back-Up Loads

GoodWe ES inverter is able to supply a continuous 4600VA output or max 6900VA in less than 10 seconds on Back-Up side to support backup loads. And the inverter has self-protection derating at high ambient temperature.

Accepted loads as below:

- Inductive Load: Max 1.5KVA for single inductive load, max 2.5KVA for total inductive load power
- Capacitive load: Total capacitive load (like computer, switch power etc.) power $\leq 3.0KVA$ (Any load with high inrush current at start-up is not accepted)

For a convenient maintenance, an SP3T switch could be installed on Back-Up and On-Grid side. Then it is adjustable to support load by Back-Up or by grid or just leave it there (Pic 21)

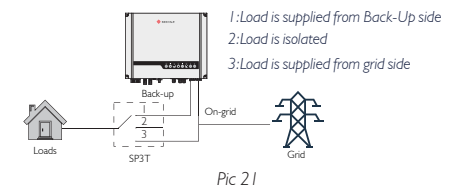

Pic 21

Declaration For Back-Up Overload Protection

Inverter will restart itself as overload protection happens. The preparation time for restarting will be longer and longer (max one hour) if overload protection repeats. Take following steps to restart inverter immediately:

- Decrease Back-Up load power within max limitation
- On PV Master \rightarrow Advanced Setting \rightarrow Click "Reset Back-Up Overload History"

2.4.4 EZMETER & CT CONNECTION

! Make sure AC cable is totally isolated from AC power before connecting EzMeter and CT^[6]

The EzMeter with CT in GoodWe product box is compulsory for ES system installation, used to detect grid voltage and current direction and magnitude, further to instruct the operation condition of ES inverter via RS485 communication.

NOTE:

1. The EzMeter and CT is well configured, please do not change any setting on EzMeter;
2. One EzMeter& CT can only be used for one ES inverter;
3. CT must be connected on the same phase with EzMeter power cable

• EzMeter & CT Connection Diagram (Pic 22)

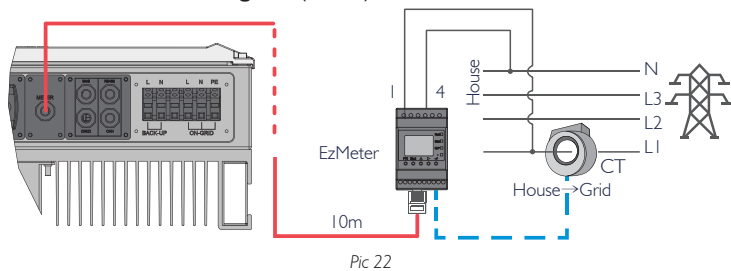

NOTE:

1. Please use the EzMeter and CT in GoodWe product box;
2. CT cable is 3m as default, could be extended to max 5m
3. EzMeter communication cable (RJ45) is attached on the inverter ("To EzMeter" cable), could be extended to max 100m, and must use standard RJ45 cable and plug, as below:



Position	Color	BMS Function	EzMeter Function	RS485
1	Orange&white	485_A2	NC	485_A
2	Orange	NC	NC	485_B
3	Green&white	485_B2	485_B1	485_A
4	Blue	CAN_H	NC	NC
5	Blue&white	CAN_L	NC	NC
6	Green	NC	485_AI	485_B
7	Brown&white	NC	485_B1	NC
8	Brown	NC	485_AI	NC

• EzMeter LED Indications

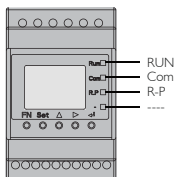

	OFF	ON	Blinking
RUN	Not working	/	Working Normally
Com (Red)	Communication fail	/	Communication OK
R-P (Red)	Sale power to grid	Buy power from grid	/
---- (Red)	/	Negative value indicator	/

Customer can also check if EzMeter communication OK on PV Master by clicking Grid symbol on home page of Local Configuration - EzMeter Communication Status, where should be "OK"

2.5 DRED & EARTH FAULT ALARM

2.5.1 DRED CONNECTION

DRED is only for Australian and New Zealand installations, in compliance with Australian and New Zealand safety requirements. And DRED device is not provided by GoodWe.

Detailed connection of DRED device is shown below:

Step 1

Screw this plate off from inverter (Pic 23)

Note: DRED device should be connected through "DRED port" as on the figure shows.

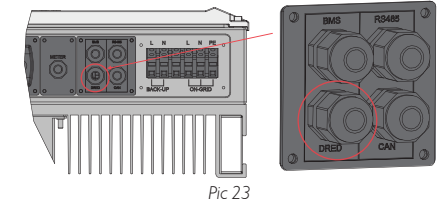

Pic 23

Step 2

1. **PLUG OUT** the 6-Pin terminal and dismantle the resistance on it (Pic 24)
2. **PLUG THE RESISTANCE OUT**, leave the 6-Pin terminal for next step.

Note: the 6-Pin terminal in the inverter has the same function of DRED device. Please leave it on the inverter if no external device connected.

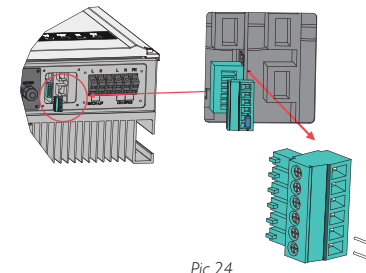

Pic 24

Step 3

1. Put DRED cable through the plate as shown on pic 25

2. Connect DRED cable on the 6-pin terminal. The function of each connection position as below:

NO	1	2	3	4	5	6
Function	DRM1/5	DRM2/6	DRM3/7	DRM4/8	REFGEN	COM/DRMO

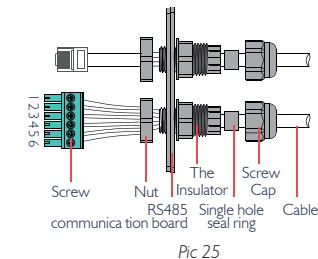

Pic 25

Step 4

Step 4: Connect DRED terminal to the right position onto the inverter (Pic 26)

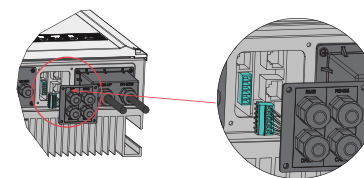

Pic 26

2.5.2 EARTH FAULT ALARM CONNECTION

GoodWe ES series inverter complies with IEC 62109-2 13.9. Fault indicator LED on inverter cover will light up and the system will email the fault information to customer.

• SYSTEM CONNECTION DIAGRAMS

NOTE: For Australian safety country, the neutral cable of On-Grid side and Back-Up side must be connected together, otherwise Back-Up function will not work.

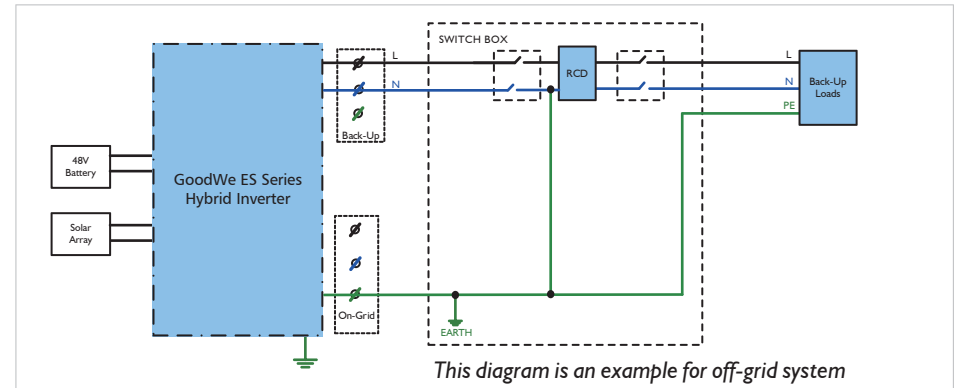
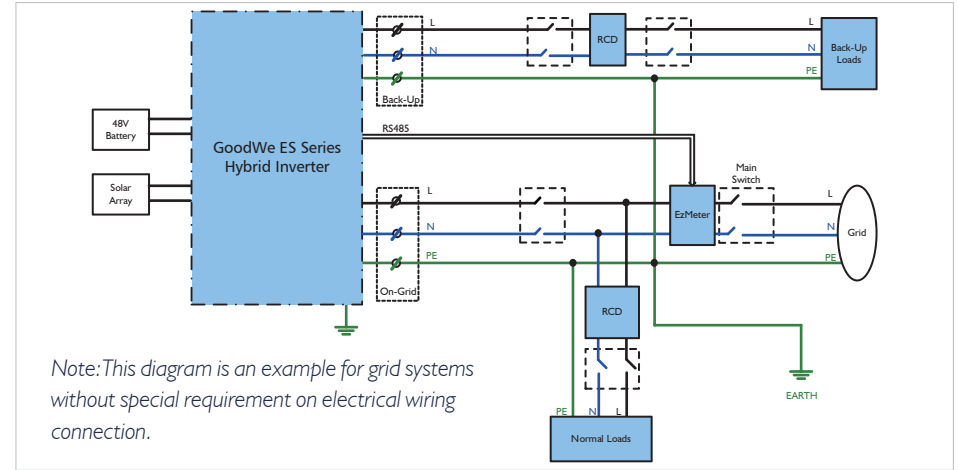
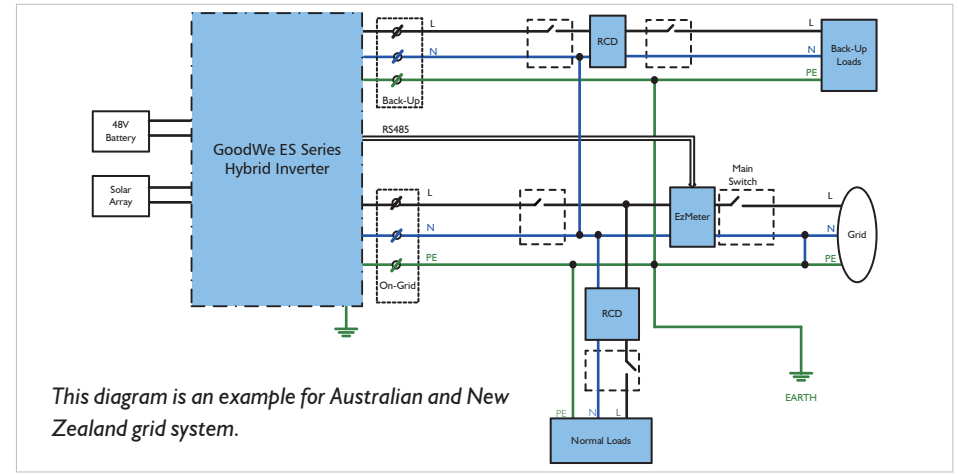

• WIRING SYSTEM FOR ES SERIES HYBRID INVERTER

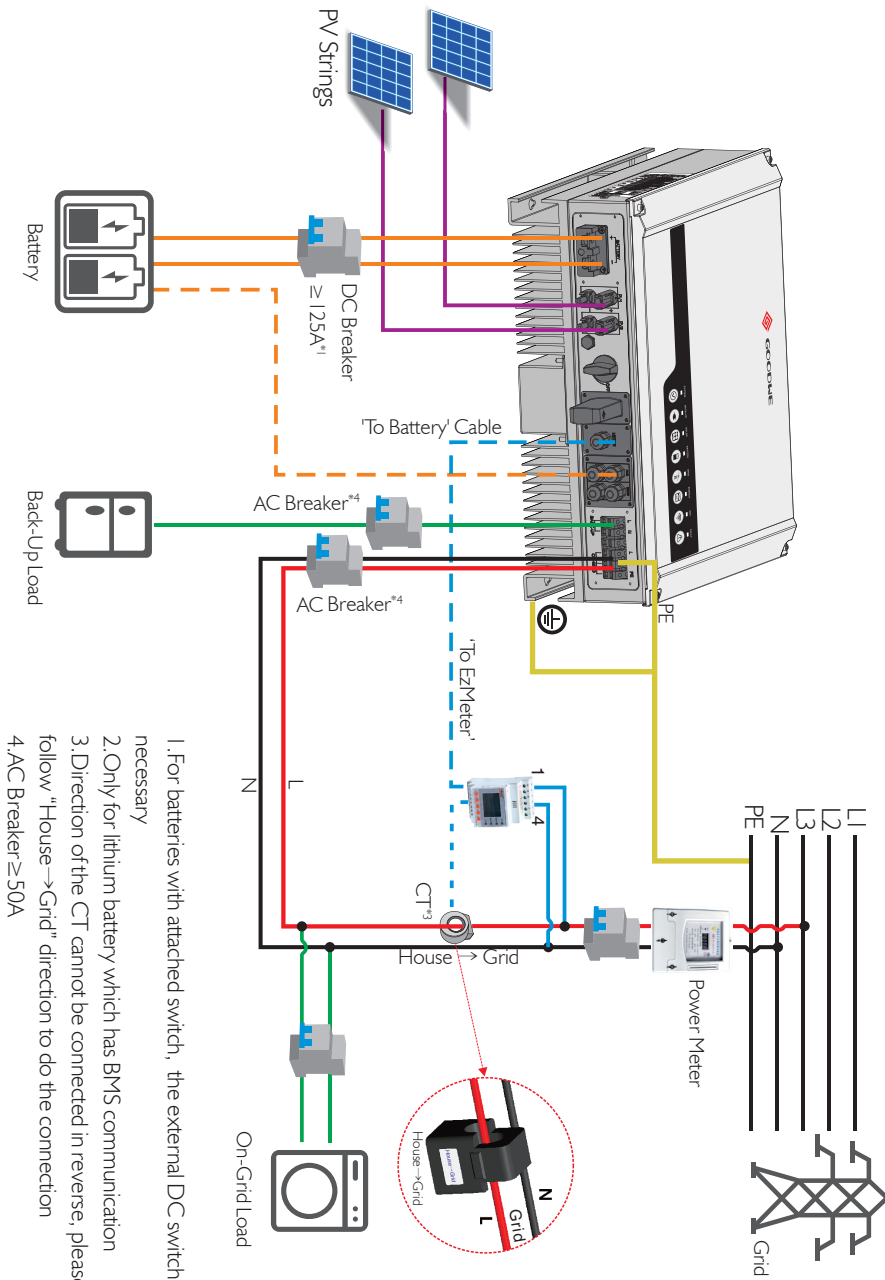

1. For batteries with attached switch, the external DC switch is not necessary
2. Only for lithium battery which has BMS communication
3. Direction of the CT cannot be connected in reverse, please follow "House→Grid" direction to do the connection
4. AC Breaker ≥ 50A

03 MAMUAL OPERATION

3.1 WI-FI CONFIGURATION

- This part shows configuration on web page
- Wi-Fi configuration is absolutely necessary for online monitoring and after-sales maintenance

PREPARATION:

1. Inverter must be powered up with only PV power
2. Need a router with available internet access to GoodWe portal www.goodwe-power.com

Step 1

1. Connect Solar-WiFi* to your PC or smart phone>(* means the last 8 characters of the inverter serial No.)
2. Open browser and login 10.10.100.253
Admin (U): admin; Password: admin
3. Then click "OK"

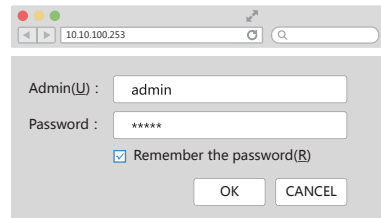

Step 2

1. Click "Start Setup" to choose your router
2. Then click "Next"

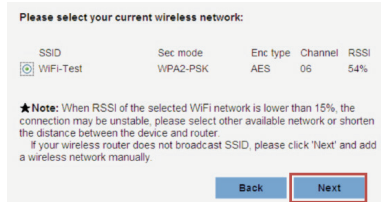

Step 3

1. Fill in the password of the router, then click "Next"
2. Click "Complete"

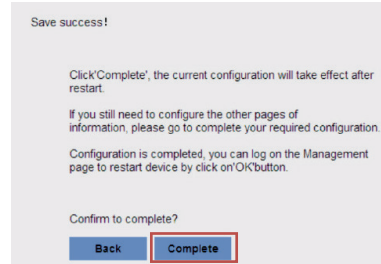
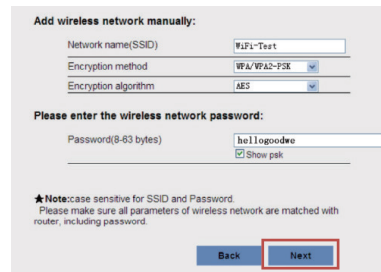

NOTE:

1. Please make sure the password, Encryption Method/Algorithm is right the same with the router's
2. If everything is right well, the Wi-Fi LED on inverter will change from double blink to quartic blink then to solid status, which means Wi-Fi is connected to GoodWe icloud successfully.
3. Wi-Fi configuration could also be done on PV Master, details please check on PV Master APP

• Wi-Fi Reset & Reload

Wi-Fi Reset means restarting Wi-Fi module, Wi-Fi settings will be reprocessed and saved automatically. Wi-Fi Reload means setting Wi-Fi module back to default factory setting.

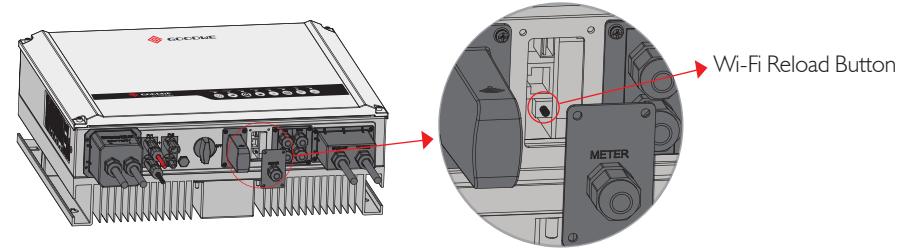

Wi-Fi Reset

- short press reload button
- Wi-Fi Led will blink for a few seconds

Wi-Fi Reload

- long press reload button (longer than 3s)
- Wi-Fi Led on inverter will double blink until doing W-Fi configuration again.

NOTE: Wi-Fi Reset & Reload function are only used when:

1. Wi-Fi losses connection to internet or cannot connect to PV Master App successfully
2. Cannot find "Solar-WiFi signal" or have other Wi-Fi configuration problem
3. Please do not use this button if Wi-Fi monitoring works well

3.2 PV Master APP OPERATION

PV Master is an external monitoring/ configuration application for GoodWe hybrid inverters, used on smart phones or pad for both Android and iOS system, main functions as below:

1. Edit system configuration to make the system work as customer needs
2. Monitor and check performance of the hybrid system
3. Wi-Fi configuration

Please download PV Master OPERATION INSTRUCTIONS from www.goodwe.com



3.3 CEI AUTO-TEST FUNCTION

PV Auto-Test function of CEI is integrated in PV Master App for Italy safety country requirements. For detailed instruction of this function please refer to PV Master OPERATION INSTRUCTIONS

04 OTHERS

4.1 ERROR MESSAGE AND TROUBLESHOOTINGS

• ERROR MESSAGE

The error messages below will be displayed on PV Master App or report by Email if the error really happen.

ERROR MESSAGE	EXPLANATION	REASON	SOLUTIONS
Utility Loss	Not available of public grid power (power loss or on-grid connection fails)	Inverter does not detect the connection of grid	<ol style="list-style-type: none"> 1. Check (use multi-meter) if AC side has voltage , Make sure grid power is available 2. Make sure AC cables are connected tightly and right well 3. If all is well, please try to turn off AC breaker and turn on again after 5 mins
VAC Failure	Grid voltage is not within permissible range	Inverter detects that AC voltage is beyond the normal range required by the safety country	<ol style="list-style-type: none"> 1. Make sure safety country of the inverter is set right 2. Check (use multi-meter) if AC voltage (Between L&N) is within a normal range (Also on AC breaker side) <ol style="list-style-type: none"> a. if AC voltage is high, then make sure AC cable complies with that required on user manual and AC cable is not too long b. if voltage is low, make sure AC cable is connected well and the jacket of AC cable is not compressed into AC terminal 3. Make sure the grid voltage of your area is stable and within normal range.
FAC Failure	Grid Efficiency is not within permissible range	Inverter detects that Grid frequency is beyond the normal range required by the safety country	<ol style="list-style-type: none"> 1. Make sure safety country of the inverter is set right 2. If safety country is right, then please check on inverter display if AC frequency (Fac) is within a normal range 3. If FAC failure only appear a few times and resolved soon, it should be caused by occasional grid frequency instability.
PV Over Voltage	DC total voltage of PV string is too high	The total voltage (short-circuit voltage) of each PV string is higher than the max DC input voltage of the inverter.	<p>Check PV string VOC is lower than Max PV Input Voltage of the inverter</p> <p>If VOC of PV string is high, please decrease panels to make sure VOC is with the max DC input voltage of the inverter.</p>
Over Temperature	Temperature inside of the inverter is too high	Inverter working environment leads to a high temperature condition	<ol style="list-style-type: none"> 1. Try to decrease surrounding temperature 2. Make sure the installation complies with the instruction on inverter user manual 3. Try to close inverter for 15 mins, then start up again.
Isolation Failure	Ground insulation impedance of PV string is too low	Isolation failure could be caused by multi reasons like PV panels are not grounded well, DC cable is broken, PV panels are aged or surrounding humidity is comparatively heavy, etc.	<ol style="list-style-type: none"> 1. Try to decrease surrounding temperature 2. Make sure the installation complies with the instruction on inverter user manual 3. Try to close inverter for 15 mins, then start up again.
Ground I Failure	Ground leakage current is over-high	Ground I failure could be caused by multi reasons like neutral cable on AC side is not connected well or surrounding humidity is comparatively heavy, etc.	<p>Check use multi-meter if there is voltage value (normally should be close to 0V) between earth & inverter frame.</p> <p>If there is a voltage, it means the Neutral & ground cable are not connected well on AC side. If it happened only at early morning, dawn or on rainy days with high air humidity, and recover soon, it should be normal</p>
Relay Check Failure	Self checking of relay fails	Neutral & ground cable are not connected well on AC side or just occasional failure	<p>Check use multi-meter if there is high voltage (normally should be lower than 10V) between N&PE cable on AC side.</p> <p>If the voltage higher than 10V, it means the Neutral & ground cable are not connected well on AC side or restart inverter.</p>
DC Injection High	/	Inverter detects a higher DC component in AC output	Try to restart inverter, check if it still happens, if not, means it is just an occasional situation or contact GoodWe
EEPROM RW Failure	/	Caused by a strong external magnetic field etc.	Try to restart inverter, check if it still happens, if not, means it is just an occasional situation or contact GoodWe
SPI Failure	Internal communication fails	Caused by a strong external magnetic field etc.	Try to restart inverter, check if it still happens, if not, means it is just an occasional situation or contact GoodWe
DC Bus High	BUS voltage is over-high	/	Try to restart inverter, check if it still happens, if not, means it is just an occasional situation or contact GoodWe
Back-Up Over Load	Back-up side is over loaded	Total Back-Up load power is higher than the nominal backup output power	Decrease Back-Up loads to make sure the total load power is lower than Back-Up nominal output power (please refer to page 12)

Note: All the errors about battery happen only on lithium battery with BMS communication.

• TROUBLESHOOTINGS

Checking Before Turning On AC power

- ✦ **Battery Connection:** Confirm the connection between ES and battery : polarities (+/-) not reversed, refer to Pic 28
- ✦ **PV Input Connection:** Confirm the connection between ES and PV panels : polarity (+/-) not reversed, refer to Pic 29
- ✦ **On-Grid & Back-Up Connection:** Confirm ON-GRID connected to power grid and Back-up to loads : polarity (L/N) not reversed, refer to Pic 30
- ✦ **EzMeter & CT Connection:** Make sure EzMeter & CT are connected between house loads and grid, and follow the “House→Grid” direction sign on CT, refer to Pic 31

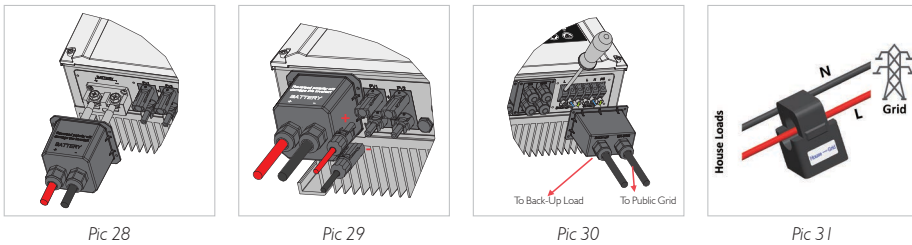

- ✦ **EzMeter Communication:**
Turn off PV and battery, turn on Loads, check if R-P led is solid or not (Pic 32). If “R-P” is not solid, means CT connected by reversed, please check:
1. if connection between EzMeter and CT (port 1 and 4 on EzMeter) is OK
2. Make sure CT connected between house loads and grid. and follow the House→Grid direction on CT (Pic 31).

Checking as Start ES Up and Turn On AC Power

- ✦ **Battery Settings, BMS Communication and Safety Country:** After connecting Solar-WiFi* (* means the last 8 characters of the inverter serial No.), check on PV Master APP Param to make sure battery type is right what you have installed, and Safety Country is right. If not right, please set it right in “Set” (Pic 33)

NOTE :
1. For lead-acid battery: All the settings should comply with the parameter of the battery, and please contact GoodWe for advices
2. For lithium batteries, BMS status is “Communication OK”
If APP BMS Status on APP says “NG” or “NA”, please check if battery wiring and settings are all right following battery connection SOP in ES QUICK INSTALLATION INSTRUCTIONS
3. Make sure CT is connected on the same phase with the power cable of EzMeter.

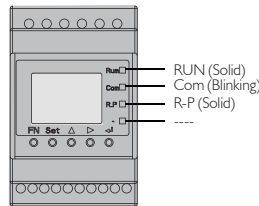

Pic 32

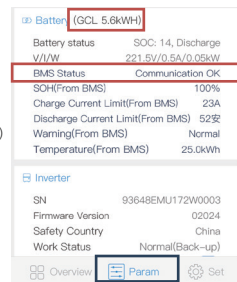

Pic 33

Problems During Operation

ES not Start Up With ONLY Battery

Solution:

1. Make sure the voltage of battery is higher than 48V, otherwise battery cannot start ES up.

ES not Start Up With ONLY PV

Solution:

1. Make sure the voltage of PV is higher than 150V (need 200V to enter on-grid mode).
2. Make sure that connection between ES and PV panels : polarities (+/-) not reversed.

No Discharge or Output From ES at Night Without PV or PV Power Lower Than Load Power:

Solution:

1. Communication between ES and EzMeter is OK or not
2. Make sure load power is higher than 150W
 - a. battery will not discharge continuously unless load power is higher than 150W
 - b. If battery still not discharge when Meter power is higher than 150W, then please check EzMeter & CT connection and direction
3. Make sure SOC is higher than 1-DOD. Or if battery discharged to below 1-DOD, than battery will only discharge again when SOC charged to 20%+ (1-DOD) / 2 and SOC > 105% -DOD (if need battery discharge immediately, battery should be restarted)
4. Check on APP if already set charge time, as during charge time, battery will not discharge (battery will charge in priority during coincident time of charge/discharge)

Battery Not Charge When PV Power Higher Than Load Power:

Solution:

1. Check if charge voltage on App (in “Param”) is properly set (for lead-acid battery) as battery cannot charge if battery voltage reaches charge voltage
2. Check if it is during discharge time set on App
3. Check if battery is fully charged or not, or battery voltage reach “charge voltage” or not

High Power Fluctuation on Battery Charge or Discharge:

Solution:

1. Check if there is a fluctuation on load power
2. Check if there is a fluctuation on PV power

Battery Does Not Charge

Solution:

1. Make sure BMS communication is OK on PV Master (for lithium batteries)
2. Check if CT connected in the right position and to right direction as on the user manual page 13
3. Check if the total load power is much higher than PV power

Questions & Answers (Q & A)

About Wi-Fi Configuration**Q: Why cannot see Solar-WiFi signal on mobile devices**

A: Normally Solar-WiFi signal could be searched right after inverter powered up. But Solar-WiFi signal will disappear when ES connected to internet. If need change settings, can connect to the router to change. If cannot see WiFi signal even not connect to router, then please try to reload WiFi (please refer to ES user manual page 18)

Q: Why cannot connect Solar-Wifi signal on my phone?

A: It is the character of the Wi-Fi module that it can connect to only one device at a time. If the signal is connected to another device at the time for some reason, then you cannot connect to the signal.

About Battery Operation**Q: Why battery does not discharge when grid is not available, while it discharge normally when grid is available?**

A: On APP, Off-Grid Output and backup function should be turned off to make battery discharge under off-grid mode.

Q: Why there is output on Back-Up side?

A: For Back-Up supply, the "Back-Up Function" on PV Master App must be turned on. Under off-grid mode or grid power is disconnected, "Off-Grid Out" function must be turned on as well

Note: As turn "Off-Grid Output" on, don't restart inverter or battery, otherwise the function will switch off automatically.

Q: On Portal, why battery SOC has a sudden jump up to 95%?

A: This normally happens on lead-acid batteries or when BMS communication fail on lithium battery. If battery enter float charge, SOC will be reset to 95% compulsively.

Q: Why battery cannot be fully charged to 100%

A: For LG battery, it will stop charge at SOC 95%. It is normal about LG battery. And also battery will stop charge when battery voltage reaches charge voltage set on PV Master APP

Q: Why battery switch always trip when starts it up (Lithium battery)?

A: For lithium battery like LG, normally the switch trips for flowing reason:

1. BMS communication fails, or battery SOC is so low to protect itself.
2. Battery SOC is too low, battery trips to protect itself.
3. An electrical short-cut happened on battery connection side. Or other reasons please contact GoodWe for details.

Q: Which battery should I use for EM?

A: For EM inverters, it could connect lithium or lead-acid batteries, with nominal voltage 48V, max charge voltage 60V

Compatible lithium batteries for now: LG RESU3.3/6.5/10, BYD B-Box 2.5/5.0/7.5/10, GCL5.6KWh, Pylon US2000B (1~4 packs). For lead-acid batteries: please contact GoodWe to confirm if it is suitable to use.

About PV Master Operation and Monitoring**Q: Why Cannot save settings on PV Master App**

A: This could be caused by losing connection to Solar-WiFi.

1. Make sure you connected Solar-WiFi (make sure no other devices connected) or router (if connected Solar-WiFi to router) and on APP home page shows connection well.

2. Make sure EM under waiting mode (on APP) before you change any settings on PV Master APP --- disconnect grid/load/battery, only leave PV connected and then restart EM till see work mode as "wait" on APP.

Q: On the App, why the data on the homepage and Param page is different, like charge/discharge, PV value, load value or grid value?

A: As the data on APP is from inverter and on home page and Param page, the data refresh frequency is different, so there will be a data inconformity between different pages on APP as well as between that on portal and APP

Q: On App, some columns show NA, like battery SOH, etc. why is that?

A: NA means App does not receive data from inverter or server, normally it is because communication problem, such as battery communication, and communication between inverter and the APP.

About EzMeter and Power Limit Function**Q: How to Act Output Power Limit function?**

A: For EM system, the function could be realized by:

1. Make sure EzMeter connection and communication well
 2. Turn on Export Power Limit function and Set the max output power to grid on APP
- Note: If Out-put Power Limit set as 0W, then there might still have deviation max 100W exporting to grid.*

Q: Why there is still power exporting to grid after I set power limit as 0W?

A: Export limit could theoretically to minimum 0W, but there will have a deviation of around 50-100W for ES system.

Q: Can I use other brand Meter to take over EzMeter in EM system or change some settings on EzMeter?

A: Cannot, because there the communication protocol is inset between inverter and EzMeter, other brand Meter cannot communicate. Also any manual setting change could cause EzMeter communication failure.

Q: What is the max current allowed going through CT on EzMeter?

A: The max current for CT is 120A

Other Questions**Q: Is there a quick way to make the system work?**

A: The shortest way, please refer to QUICK INSTALLATION INSTRUCTIONS and PV MASTER APP INSTRUCTION

Q: What kind of load can I connect on Back-Up side?

A: Please refer to user manual on page 12

Q: Whether the warranty of the inverter still valid if the installation or operation does not follow the user manual instructions, for some special conditions when we cannot 100% follow them?

A: Normally if any problem caused by disobey the instructions on user manual, we can provide technical support to help solve the problem, but cannot guarantee a replacement or returns. So if there is any special condition when you cannot 100% follow the instructions, please contact GoodWe for suggestions.

4.2 DISCLAIMER

The EM series hybrid inverters are transported, used and operated under environmental and electrical conditions. GoodWe has the right not providing after-sales services or assistance under following conditions:

- Inverter is damaged during transferring
- Inverter is out of warranty year and extended warranty is not bought
- Inverter is installed, refitted or operated in improper ways without authority from GoodWe
- Inverter is installed or used under improper environment or technical condition mentioned in this user manual, without authority from GoodWe
- Installation or configuration of the inverter does not follow requirements mentioned in this user manual
- The inverter is installed or operated against the requirements or warnings that are mentioned in this user manual
- Inverter is broken or damaged by any force majeure like lightning, earthquake, fire hazard, storm and volcanic eruption etc.
- Inverter is disassembled, changed or updated on software or hardware without authority from GoodWe
- Inverter is installed, used or operated against any related items in international or local policies or regulations
- Any non-compatible batteries, solar panels, loads or other devices connected to EM system

Note: GoodWe will keep right to explain all the contents in this user manual.

* Maintenance

The inverter requires periodically maintenance, details as below:

NOTE: Make sure inverter is totally isolated from all DC and AC power for at least 5 mins before maintenance

Heat sink: please use clean towel to clean up heat sink once a year

Torque: please use torque wrench to tighten AC and battery wiring connection once a year

DC switch: check DC switch regularly, active the DC switch 10 times in a row once a year. operating DC switch will clean contacts and extend lifespan of DC switch

Water-proof covers: check if water-proof covers of RS485 and other part are fasten once a year

4.3 TECHNICAL PARAMETERS AND CERTIFICATES

• TECHNICAL PARAMETERS OF EM INVERTERS

	GW3648D-ES	GW5048D-ES
Battery Input Data		
Supported Battery Type ^[1]	Li-Ion or Lead-acid	Li-Ion or Lead-acid
Nominal Battery Voltage (V)	48	48
Max. Charge Voltage (V)	≤60 (Configurable)	≤60 (Configurable)
Max. Charge Current (A) ^[1]	75	100
Max. Discharge Current (A) ^[1]	75	100
Battery Capacity (Ah) ^[2]	50~2000	50~2000
Charge Pattern for Li-Ion battery	Self-adaption to BMS	Self-adaption to BMS
PV String Input Data		
Max. DC Input Power (W)	4600	6500
Max. DC Input Voltage (V)	580	580
MPPT Voltage Range (V)	125~550	125~550
Start-up Voltage (V) ^[3]	150	150
MPPT Voltage Range for Full Load(V)	170~500	215~500
Nominal DC Input Voltage (V)	360	360
Max. Input Current (A)	11/11	11/11
Max. Short Current (A)	13.8/13.8	13.8/13.8
PV Over-current Protection (A)	21	21
PV Back-feed Current (A)	0	0
No. of MPP Tracker	2	2
String No. per MPP Tracker	1	1
DC Overvoltage Category	II	II
AC Output Data (Back-Up)		
Max. Output Apparent Power (VA)	3680	4600
Peak Output Apparent Power (VA) ^[4]	5520, 10s	6900, 10s
Max. Output Current (A)	16 ^[5]	20
Nominal Output Voltage (V)	230 (+/-2%) single phase	230 (+/-2%) single phase
Nominal Output Frequency (Hz)	50/60(+/-0.2%)	50/60(+/-0.2%)
Back-Up Over Current Protection (A)	30A	30A
Output Inrush Current (Peak/Duration)	55A, 2μs	55A, 2μs
Automatic Switch Time (ms)	10	10
Max. Output Fault Current (Peak/Duration)	43A, 10s	43A, 10s
Output THDv (linear load)	<3%	<3%

[1] Lead acid battery use refers to *Approved Battery Statement*

The actual charge and discharge current also depends on the battery

[2] For off-grid system, battery capacity should be ≥ 100Ah

[3] If there is no battery connected, inverter starts feeding into grid only if PV voltage > 200V

[4] On condition of battery and PV power being enough

[5] 18A for Italy, 16A for other country

	GW3648D-ES	GW5048D-ES
AC Output Data (On-grid)		
Nominal Power Output to Grid (W)	3680	4600
Max. Apparent Power Output to Grid(VA) ^[6]	3680	5100
Max. Apparent Power From Grid(VA)	7360	9200
Nominal Output Voltage (V)	230 single phase	230 single phase
Nominal Output Frequency (Hz)	50/60	50/60
Max. AC Output Current to Grid (A) ^[7]	16	24.5
Max. AC Current from Grid (A) ^[8]	32	40
AC Back-feed Current (A)	0	0
Max. Output Fault Current (Peak/Duration)	43A, 0.2s	43A, 0.2s
Output Inrush Current (Peak/Duration)	55A, 5μs	55A, 5μs
Input Inrush Current (Peak/Duration)	60A, 3μs	60A, 3μs
Output Power Factor	~ 1 (Adjustable from 0.8 leading to 0.8 Lagging)	
Output THDi (@Nominal Output)	< 3%	
AC Overvoltage Category	III	
Efficiency		
Max. Efficiency	97.6%	
Max. Battery to Load Efficiency	94.0%	
Europe Efficiency	97.0%	
MPPT Efficiency	99.9%	
General Data		
Operation Temperature Range (°C)	-25~60	
Storage Temperature Range (°C)	-30~65	
Relative Humidity	0~95%	
Moisture Location Category	4K4H	
External Environment Pollute Degree	Grade 1,2,3	
Environment Category	Outdoor & Indoor	
Operation Altitude (m)	≤4000	
Cooling system	Nature Convection	
Noise (dB)	<25	
User Interface	LED, APP	
Communication With BMS ^[9]	CAN, RS485	
Communication With EzMeter	RS485	
Communication With Portal	Wi-Fi	
Weight (kg)	28	30
Size (Width*Height*Depth mm)	516*440*184	
Mounting	Wall Bracket	
IP Rating	IP65	
Protective Class	I	
Standby Self-Consumption (W)	< 13	
Topology	High Frequency Isolation	

[6] GW5048D-ES:4600 for VDE-AR-N4105, 4950 for AS4777.2; GW3648D-ES: 4050 for CEI 0-21

[7] GW5048D-ES:21.7A only for Australia and New Zealand, GW3648D-ES: 18A for CEI 0-21

[8] GW5048D-ES:40A to inverter and backup, max 21.5A to inverter, GW3648D-ES:32A to inverter and backup, max 18A to inverter

[9] Default communication with BMS is CAN, requirement RS485 needs special configuration process

	GW3648D-ES	GW5048D-ES
Protection		
Anti-islanding Protection	Integrated (AFD)	
PV String Input Polarity Reverse Protection	Integrated	
Isolation Resistor Detection	Integrated	
Residual Current Monitoring Unit	Integrated	
Output Over-current Protection	Integrated	
Output Short Protection	Integrated	
Output Over-voltage Protection	Integrated	
Certifications & Standards		
Grid Regulation	AS/NZS 4777.2:2015, G83/2, G100, CEI 0-21, VDE-AR-N4105, VDE0126-1-1, NRS 097-2-1	AS/NZS 4777.2:2015, G59/3, G100, CEI 0-21, VDE-AR-N4105, VDE0126-1-1, NRS 097-2-1
Safety Regulation	IEC/EN62109-1 & -2, IEC62040-1	
EMC	EN61000-6-1, EN61000-6-2, EN61000-6-3, EN61000-6-4, EN61000-4-16, EN61000-4-18, EN61000-4-29	

• **CERTIFICATES OF ES SERIES**



G100 IEC62109-1 CEI 0-21
RD1699 VDE0126-1-1 VDE-AR-N 4105 NRS 097-2-1

• **OTHER TEST**

For Australian requirements, in the THDi test, there should add Zref between inverter and mains.

RA , XA for Line conductor
RN, XN for Neutral conductor

Zref:
RA=0,24;XA=j0,15 at 50Hz;
RN=0,16;XN=j0,10 at 50Hz.

4.4 WARNING QUICK CHECK LIST

- [1] Inverter cannot be installed near flammable, explosive or strong electro-magnetic equipment, page 06
- [2] Remember that this inverter is heavy! Please be careful when lifting out from the package, page 07
- [3] The polarity of PV strings or on the inverter cannot be connected by reverse, otherwise inverter could be damaged, page 08
- [4] Make sure battery switch is off and battery nominal voltage meet ES specification before connecting battery to inverter and make sure inverter is totally isolated from PV and AC power, page 09
- [5] Make sure inverter is totally isolated from any DC or AC power before connecting AC cable, page 11
- [6] Make sure AC cable is totally isolated from AC power before connecting EzMeter and CT, page 13

Appendix: Protection Category Definition

Overvoltage Category Definition

Category I	Applies to equipment connected to a circuit where measures have been taken to reduce transient overvoltage to a low level
Category II	Applies to equipment not permanently connected to the installation. Examples are appliances, portables tools and other plug-connected equipment
Category III	Applies to a fixed equipment downstream of and including the main distribution board. Examples are switchgear and other equipment in an industrial installation
Category IV	Applies to equipment permanently connected at the origin of an installation (upstream of the main distribution board). Example are electricity meters, primary over-current protection equipment and other equipment connected directly to outdoor open lines

Moisture Location Category Definition

Moisture Parameters	Level		
	3K3	4K2	4K4H
Temperature Range	0~+40 C	-33~+40 C	-20~+55 C
Humidity Range	5%~85%	15%~100%	4%~100%

Environment Category Definition

Environment Condition	Ambient Temperature	Relative Humidity	Applied to
Outdoor	-20 ~ 50 C	4% ~ 100%	PD3
Indoor Unconditioned	-20 ~ 50 C	5% ~ 95%	PD3
Indoor Conditioned	0 ~ 40 C	5% ~ 85%	PD2

Pollution Degree Definition

Pollution Degree I	No pollution or only dry, non-conductive pollution occurs. The pollution has no influence
Pollution Degree II	Normally only non-conductive pollution occurs. Occasionally, however, a temporary conductivity caused by condensation must be expected.
Pollution Degree III	Conductive pollution occurs, or dry, non-conductive pollution occurs, which becomes conductive due to condensation, which is expected.
Pollution Degree IV	Persistent conductive pollution occurs, for example, the pollution caused by conductive dust, rain and snow.